

Advanced Performance UniBloc Balances

AP Series



AP Series

Advanced Performance UniBloc Balances

Faster Response and Higher Stability

High Speed

Fast weighing response

Stress Free

Reliable weighing results

Efficiency-driven Conveniences

Various productivity-boosting weighing applications

* All models: USB-B type connector as standard APW: USB-A type and B type as standard



* AP224W with optional ionizer

High Speed

Fast weighing response

Fastest Response in Its Class* with UniBloc AP Technology

Shimadzu analytical balances boast a one-piece UniBloc weighing sensor, which is now even more advanced. The improved UniBloc sensor offers up from 7 seconds (previous model) to 1.5 seconds faster response.

* Compared to previous Shimadzu models

Response Time Comparison

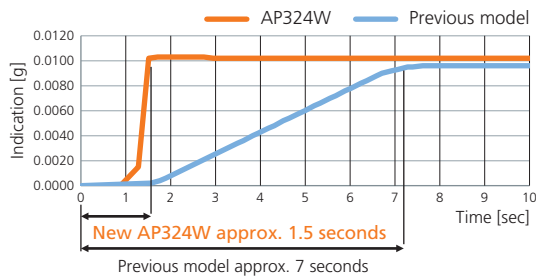

Model	AP324W	AU (previous model)
0.1 mg	1.5 sec (central value)	7 sec (central value)

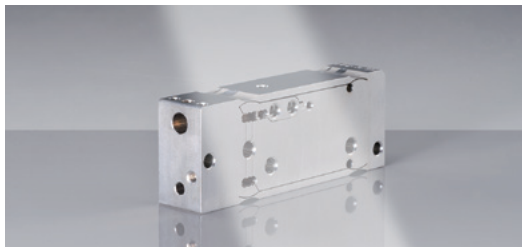

New Weighing Sensor: UniBloc AP

Using the new UniBloc AP weighing sensor significantly improves core performance (compared to previous Shimadzu models). This allows more accurate measurements with less stress on the operator.

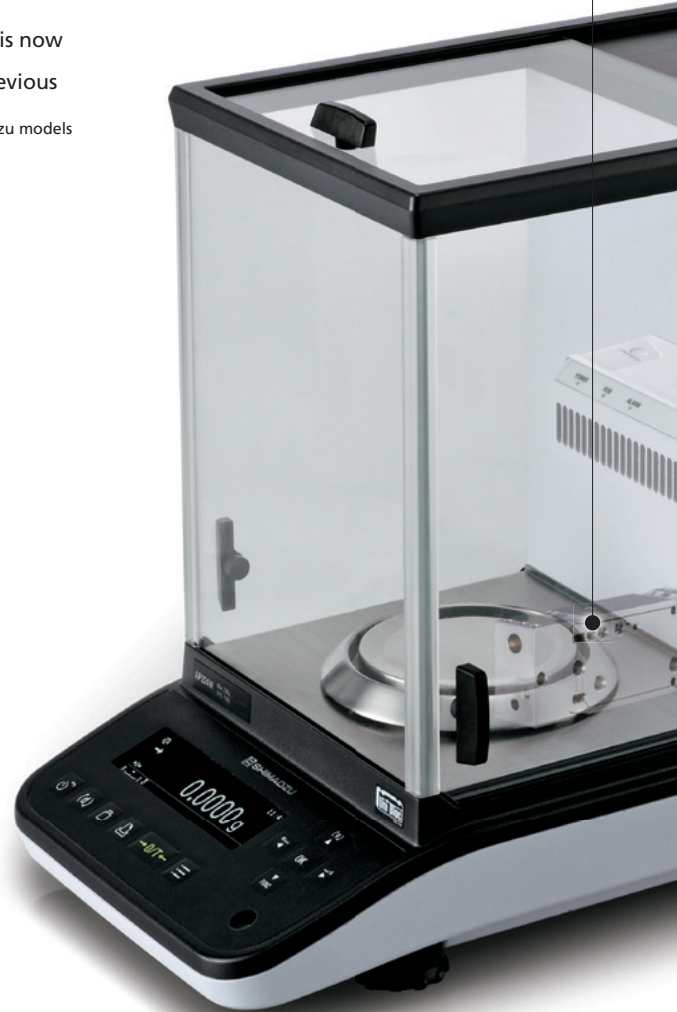

Advanced Digital Control for Fast, Reliable Weighing

The improved measuring feel provides for more comfortable use.

AP-i System (intelligent - Advanced Processing System)

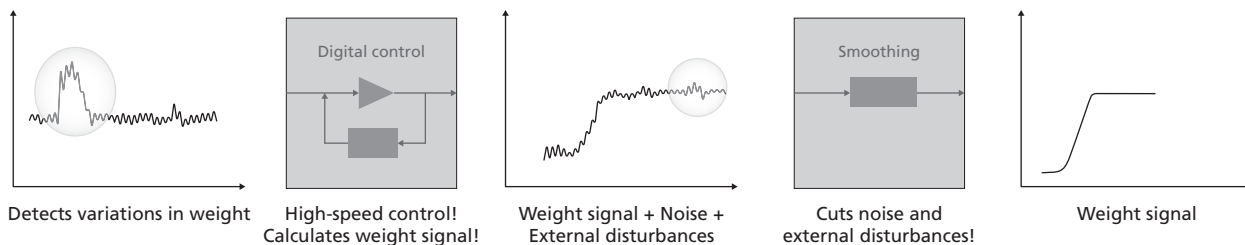

Measuring feel has been significantly improved by using the advanced digital control technology and smoothing technology. AP-i system provides reliable weighing even in a challenging environment and enables high-speed weighing of small samples.

Stress Free

Reliable weighing results

Built-in High-Performance Ionizer (Optional)

A new ionizer is able to remove static electricity in about 1/10 the time of previous ionizers

This unit allows acquisition of reliable weighing results by eliminating static electricity that can affect measurements without scattering powder.

Note: Example of typical static electricity removal time ($\pm 1000\text{ V} \rightarrow \pm 100\text{ V}$):

1 sec for STABLO-AP and 10 sec for STABLO-EX



AC Method with Excellent Ion Polarity Balance

Mount the STABLO-AP in the balance and use it as a built-in model

Comparison of Static Removal Rates (Typical Examples)

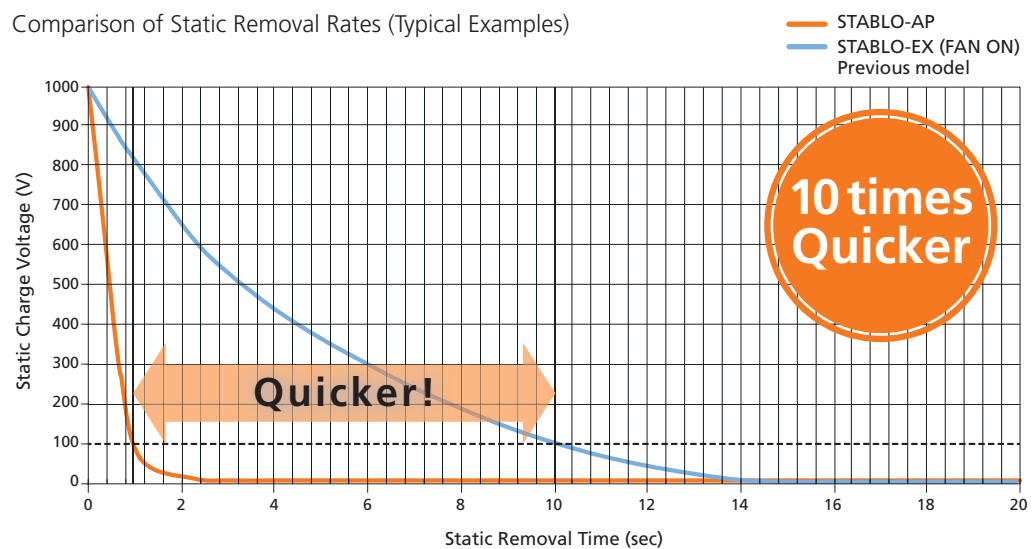

Measurement Conditions

- Time from $\pm 1000\text{ V}$ to $\pm 100\text{ V}$
- Distance between CPM and ionizer: 100 mm
- $150 \times 150\text{ mm}$ CPM (20 pF) used

Efficiency-driven Conveniences

Various productivity-boosting weighing applications

USB Offers Greater Expandability **NEW**

(USB host: APW only)

Equipped standard with an RS-232C connector, a USB device and a USB host. You can now simultaneously send output to both a computer and printer or connect a USB flash drive, a barcode reader, or an external numeric keypad.



USB and RS-232C are standard



USB host is available for APW

USB flash drive

Connecting a USB memory device allows you to record large amounts of weighing data in CSV format. Used in combination with the interval output function, it also enables recording of long-term changes over time.



Example of a record:

- File name
- Date and time
- Weighing value

Display capture function

Weighing display can be recorded into USB memory in BMP format. User name, date/time, setting can be done with display information.



Numeric keypad

Connecting a common external numeric keypad makes it easier to enter numeric values. This is especially useful for entering the mass value of weights, setting upper/lower limit values for the comparator function, or entering the sample count during piece counting mode.



Barcode reader

A barcode reader can be connected. Simply reading a barcode makes it possible to input user ID/Password. It is possible to manage sample IDs using barcodes.



An example of login by barcode

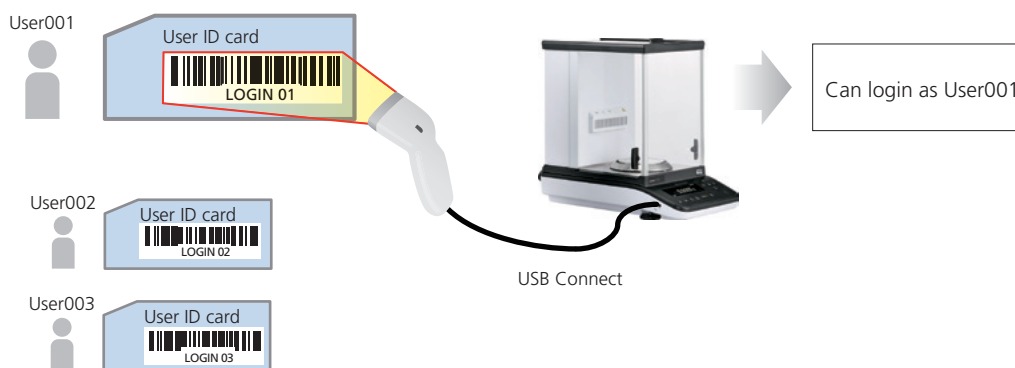

An ID and password are needed to login to the AP series if protected access is activated. With the barcode, an operator can login by scanning the barcode instead of inputting an ID and password.

* The latest information can be seen from the Shimadzu website (<http://www.shimadzu.com/an/balance/>)

Easy-to-Read Organic EL Display

(All models)

Because the pixel elements in the organic electroluminescence display emit light, the screen can be seen clearly even in dark locations. Multi-language display capability* provides a more intuitive operating interface. A wider viewing angle has also improved the visibility of measurement values, which helps increase the efficiency of measuring operations.



Clearly visible from the side

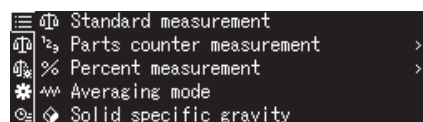

English example

Exceptional Visibility

The visibility remains the same even when viewed from different angles. The viewing angle is a wide expanse of ± 85 degrees, both vertically and horizontally. That means the display is clearly visible even when working beside the balance. A high-resolution dot-matrix display makes it easy to read even detailed text.

* Japanese, English and Chinese

Periodic Inspection Support Function **NEW**

(APW/APX only)

AP series supports periodic inspections. The function allows inspection of repeatability, corner load error, and linearity by simply following instructions displayed on the screen.

Example of printing

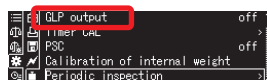

Select the inspection mode.



In this case, repeatability inspection is selected.

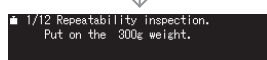

Place standard weights as instructed.

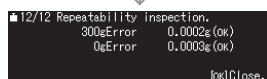

Results are displayed.



Printing sample

REPEATABILITY	
LOAD	= 150 g
MPE	= 0.0010 g

N001	IL = 150.0000 g
I0	= 0.0000 g
N002	IL = 149.9999 g
I0	= -0.0001 g
N003	IL = 149.9999 g
I0	= -0.0001 g
N004	IL = 149.9999 g
I0	= 0.0000 g
N005	IL = 149.9999 g
I0	= 0.0000 g
N006	IL = 149.9999 g
I0	= 0.0000 g
TEST RESULTS	
LOAD	= 0.0001 g
(PASSED)	
ZERO	= 0.0001 g
(PASSED)	

IL: Loaded weight
I0: Zero value



Buffer Solution Preparation Mode **NEW**

(APW only)

- **Recipes for 13 commonly used buffer solutions are included as standard**

Preparation recipes for commonly used buffer solutions are provided as standard.

e.g. disodium phosphate, sodium acid citrate

- **Instructions are shown on the display**

The target weighing value is shown on the display and analog bar in order to compare the target with the current weight. Manual calculation is not needed.

- **Record function**

Record output with date, time and operator name.

pH level of mobile phase (eluent) solutions used in liquid chromatographs is adjusted to improve separation of components and extend the life of columns. This pH adjustment process is performed using a buffer solution. Currently, the most common method is using a pH meter to measure the pH as the solution is prepared; however, this process requires considerable time and effort, which can cause operational bottlenecks.

An alternative method is available that does not require a pH meter. It involves preparing solutions by weighing fixed theoretically calculated quantities of an acid and base.

AP series supports weighing these acids and bases. If the type and quantity of the buffer solution is specified, the balance displays the type and quantity of sample that should be weighed. Then the buffer solution can be prepared easily by adding water to the specified quantity of sample weighed accordingly.

Example of preparation by AP series

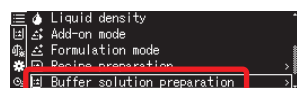

Select the buffer solution mode.

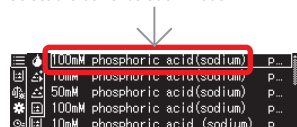

Specify the type and quantity.

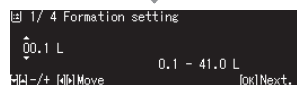

Displays the name and quantity of sample.

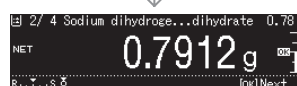

Prepare as instructed on screen.

Complete buffer solution



* Results can be printed with date/time and user ID.

Number	Buffer solution preparation list		
1	100mM	phosphoric acid (sodium)	pH = 2.1
2	10mM	phosphoric acid (sodium)	pH = 2.6
3	50mM	phosphoric acid (sodium)	pH = 2.8
4	100mM	phosphoric acid (sodium)	pH = 6.8
5	10mM	phosphoric acid (sodium)	pH = 6.9
6	20mM	citric acid (sodium)	pH = 3.1
7	20mM	citric acid (sodium)	pH = 4.6
8	10mM	tartaric acid (sodium)	pH = 2.9
9	10mM	tartaric acid (sodium)	pH = 4.2
10	20mM	acetic acid (ethanolamine)	pH = 9.6
11	100mM	acetic acid (sodium)	pH = 4.7
12	100mM	boric acid (potassium)	pH = 9.1
13	100mM	boric acid (sodium)	pH = 9.1

Sample Preparation **NEW**

(APW only)

Typically, preparation of a standard sample solution requires tedious calculations.
AP series simplifies the process with automated calculations.

Example of preparation by AP series

Weigh 25 mg Amitriptyline to make standard solution

Standard sample of Amitriptyline is Amitriptyline Hydrochloride .

Calculation is essential to determine part of Acidum hydrochloricum by molecular weight to make 100 mg/mL Amitriptyline solution.

Molecular weight of Amitriptyline: 277.4

Molecular weight of Acidum hydrochloricum: 36.5

Molecular weight of Amitriptyline Hydrochloride: $277.4 + 36.5 = 313.9$

To compare the molecular weight of Amitriptyline Hydrochloride with Amitriptyline, the following calculation is necessary.

$313.9/277.4 = 1.132$

The molecular weight of Amitriptyline Hydrochloride is 1.132 times of Amitriptyline.

So, if 25mg of Amitriptyline is used, it follows that the weight of Amitriptyline Hydrochloride should be:

$25 \text{ mg} \times 1.132 = 28.3 \text{ mg}$.

Hence, 28.3 mg of Amitriptyline Hydrochloride is needed to make the correct standard solution.

Standard solution of Amitriptyline

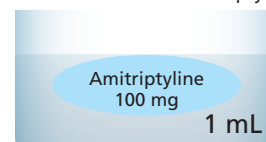

Amitriptyline Hydrochloride



No need for manual calculation

AP series can automatically calculate the sampling weight using the molecular amount of the standard sample, molecular weight of unnecessary sample, and the target value in order to reach the correct concentration solution.

Just weigh the target weight value on display and the target weight of the standard sample can be obtained.

Target weighing value	→	Target	0.0283 g
Current sample value	→	Gross	0.0283 g
Standard sample value	→	Picking	0.0250 g

"OK" mark shown when target weight is reached.

Checking weighing conditions on the same display

Functions Recommended for the Pharmaceutical Industry

High-Security User Management **NEW**

(All models)

Operations can be kept secure with user ID and password protection. Access rights can be specified separately for each user to prohibit unauthorized actions such as performing calibration or changing the settings. User IDs can also be used for barcode management.



User Selection Screen

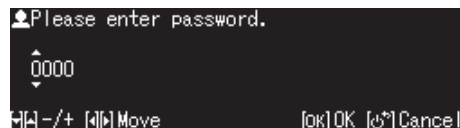

Password Inputting Screen

Printing Data in Accordance with Various Regulations **NEW**

(All models)

Functionality for customizing the content of printed information supports compliance with various ISO, GLP, GMP, and other requirements.

<Printed content>

- Date
- Time
- User name
- Balance manufacturer name
- User ID
- Serial number
- Balance ID
- Software version
- Minimum sample quantity

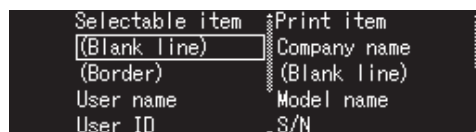
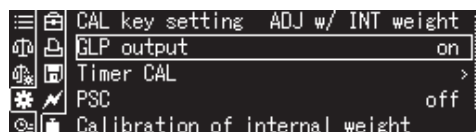

Example of selecting printed content

An example of printing	
Title of result	-----CAL-INTERNAL-----
Manufacturer name	SHIMADZU CORP.
Model name	TYPE AP324W
Serial number	SN 000000001
Date	DATE 2014 Dec. 17
Time	TIME 15.51.55
User name	YAMADA TARO
Standard weight value	REF= 300.0000g
Weighing value before calibration	BFR= 299.9999g
Weighing value after calibration	AFT= 300.0000g
	-----COMPLETE-----
Signature	-----SIGNATURE-----

Minimum Sample Quantity (Warning Function) **NEW**

(All models)

Reproducibility can be confirmed by repeatedly measuring weights as instructed by AP series. The minimum sample quantity is automatically determined from the standard deviation and recorded in AP series.

If the minimum sample quantity requirement is not satisfied during measurement, an indicator flashes to warn the user.



Minimum sample quantity

Recipe Function **NEW**

(AP-W only)

Sample recipes can be registered, allowing users to simply follow instructions on display.

Supporting More Efficient Laboratory Work and Providing Higher Reliability.

Weighing results and analysis results can be stored in a database. Reports can be generated according to results in a prescribed format.

Analytical Balance AP series



Weighing results by Balance

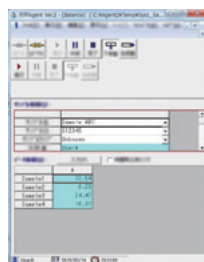

Analysis results by LC

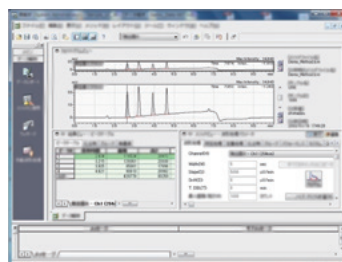

UHPLC Nexera X2



Analysis results by LC

Weighing results by Balance

Sample No.	Sample Name	Lot No.	Weight (mg)	Analysis Results
1	Demo_Data101.tst	1 0-0-1	2018/10/20 18:11	System Administrator 2018/10/18 17:42
2	Demo_Data101.tst	1 0-0-1	2018/10/20 18:11	System Administrator 2018/10/18 17:38
3	Demo_Data101.tst	1 0-0-1	2018/10/20 18:11	System Administrator 2018/10/18 17:26
4	Demo_Data101.tst	1 0-0-1	2018/10/20 18:11	System Administrator 2018/10/18 17:16
5	Demo_Data101.tst	1 0-0-1	2018/10/20 18:11	System Administrator 2018/10/18 17:04
6	Demo_Data101.tst	1 0-0-1	2018/10/20 18:11	System Administrator 2018/10/18 16:52
7	Demo_Data101.tst	1 0-0-1	2018/10/20 18:11	System Administrator 2018/10/18 16:40
8	Demo_Data101.tst	1 0-0-1	2018/10/20 18:11	System Administrator 2018/10/18 16:28
9	Demo_Data101.tst	1 0-0-1	2018/10/20 18:11	System Administrator 2018/10/18 16:16

LabSolutions software can store analysis results and weighing results in a database at the same time.

* When you use the LabSolutions software, you need the Balance Agent at the same time. If you have any questions about details, please feel like to contact us.

Report example

Lot No.	23006			
STD	Lot No. 12507-033			
	Wt / Gs = 6.5			
	(mg)			
1	49.6			
2	3825590			
3	3296695			
4	1.1604			
5	42.582			
6	42.458			
7	42.588			
8	0.3			
SAMPLE				
	c			
	d			
	(c / d)			
	(%)			
1	3725433	3257102	1.1489	98.2
2	3782242	3253358	1.1650	100.1
3	3760338	3250068	1.1570	99.8
4	3777347	3250858	1.1620	99.7
5	3786125	3249101	1.1659	100.1
6	3774629	3249595	1.1616	99.7
7	3791798	3247394	1.1677	100.2
8	3787810	3250429	1.1653	100.0
9	3774437	3252380	1.1611	99.7
10	3765883	3250620	1.1585	99.4
	Ave			99.6
	C.V (%)			0.6
	s			2.2
				0.59
				1.7

The report can be generated automatically according to results.

Wide Variety of Functions to Support Users

Smart Settings

(All models)

Response and stability settings can be changed during measurements with a single touch. Changing the settings for different applications can make it even easier to use.



User-friendly arrow keys

The indicator is operated using the left and right arrow keys. Moving the setting toward [R] prioritizes response, which makes it easier to operate the balance. Conversely, moving it toward [S] makes it easier to stabilize weight values, which can improve readability in environments with vibration.



Moving it left prioritizes response and moving it right prioritizes stability. Five setting levels are available.

Specific Gravity Measurement

(All models)

In combination with an optional specific gravity measurement kit, the balance can be used to measure specific gravity.

By using sinkers, the specific gravity of liquid can be measured as well. This allows measurement of the specific gravity of metals, rubbers, plastics, and other materials easily.



First measure the empty weight.

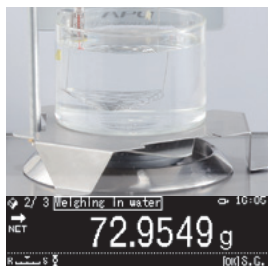

Then place it in the container filled with water, as instructed on the screen.



The specific gravity value is displayed using simple steps.



PSC and Clock-CAL

(APW/APX only)

A Perfect Self Calibration (PSC) function is included. The analytical balance automatically detects any temperature changes that could affect sensitivity and automatically starts calibration.

The Clock-CAL function enables automatic calibration at a pre-specified time (for example, before starting work, during lunch, or after work hours).

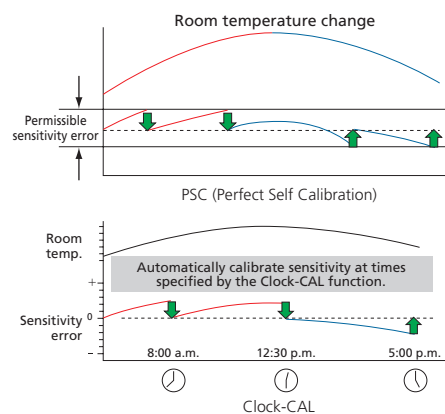

Other Functions

Piece counting, statistical calculation, mol unit measurement and pass/fail decisions

Recommended functions of AP series for each industry

Various user support functions are available in AP series.
AP series provides solutions for each industry as follows.

 <h2>Chemical</h2>	<p>Faster response time provides stress-free measurement. And, AP series has functions to support sample preparation for various analytical techniques, especially for Liquid Chromatography. In addition, the Aluminum body has higher chemical resistance.</p> <ul style="list-style-type: none">Built-in IonizerPrinting format customizeUSB accessoriesPeriodic inspection supportBuffer solution preparationSample preparationBarcode reader function
 <h2>Pharmaceutical</h2>	<p>AP series provides a high level of measurement reliability to meet the strictest of customer requirements. Moreover, the customizable printing format function for ISO/GLP/GMP, minimum sample quantity function and security function support compliance with industry regulations.</p> <ul style="list-style-type: none">Built-in IonizerPrinting format customizeUSB accessoriesPeriodic inspection supportMinimum sample quantityBuffer solution preparationSample preparationBarcode reader function
 <h2>Food</h2>	<p>Increasing attention is placed on food safety and traceability globally. Higher accuracy of weighing can play a part. PSC (Perfect Self Calibration) starts calibration automatically by temperature changes. The Clock-CAL function can be used to have the balance automatically calibrated at the preset time. The ionizer can remove static without scattering sample.</p> <ul style="list-style-type: none">Built-in IonizerPrinting format customizeUSB accessoriesPeriodic inspection supportBuffer solution preparationSample preparationBarcode reader function
 <h2>Car, Heavy industry</h2>	<p>Car manufacturers focus on accuracy management. The periodic inspection function supports management in this area. Specific gravity measurement of metal samples can be accomplished easily. This function supports quality control for materials.</p> <ul style="list-style-type: none">Printing format customizeUSB memoryPeriodic inspection supportBarcode reader function
 <h2>University</h2>	<p>Weighing balances are necessary tools in academic institutions, where durability is a prized quality. AP series offers excellent durability and stability for long-term use.</p> <ul style="list-style-type: none">Built-in IonizerPrinting format customizeUSB memoryBuffer solution preparationSample preparation

* Ionizer, printer and specific gravity kit are optional items.

AP Series Specifications

W Series Analytical Balances

Series	W Series		
Model	AP124W	AP224W	AP324W
Capacity	120 g	220 g	320 g
Minimum Display	0.1 mg		
Calibration Weight	Built-in		
External Calibration Weight Range for Span Calibration	45 to 120.009 g (100 g)	95 to 220.009 g (200 g)	95 to 320.009 g (300 g)
Repeatability (Standard deviation)	0.1 mg		0.15 mg
Minimum Weight*1	200 mg		
Linearity	±0.2 mg	±0.3 mg	
Response Time*2	Approx. 2 sec.		
Operating Temperature/Humidity Range	5 to 40°C 20 to 85%*3		
Sensitivity Stability Against Temperature Range	±2 ppm/°C (10 to 30°C)		
Pan Size	ø91 mm		
Body Dimensions	Approx. W 212 × D 367 × H 345 mm		
Weight	Approx. 7.0 kg		
Display	OEL display (dot matrix)		
Input/Output Terminal	RS-232C (D-sub9P plug) USB host (Type A) USB device (Type B) Ionizer		

X Series / Y Series Analytical Balances

Series	X Series			Y Series		
Model	AP124X	AP224X	AP324X	AP124Y	AP224Y	AP324Y
Capacity	120 g	220 g	320 g	120 g	220 g	320 g
Minimum Display	0.1 mg					
Calibration Weight	Built-in			No		
External Calibration Weight Range for Span Calibration	45 to 120.009 g (100 g)	95 to 220.009 g (200 g)	95 to 320.009 g (300 g)	45 to 120.009 g (100 g)	95 to 220.009 g (200 g)	95 to 320.009 g (300 g)
Repeatability (Standard deviation)	0.1 mg		0.15 mg	0.1 mg		0.15 mg
Minimum Weight*1	200 mg					
Linearity	±0.2 mg		±0.3 mg	±0.2 mg		±0.3 mg
Response Time*2	Approx. 2 sec.					
Operating Temperature/Humidity Range	5 to 40°C 20 to 85%*3					
Sensitivity Stability Against Temperature Range	±2 ppm/°C (10 to 30°C)					
Pan Size	ø91 mm					
Body Dimensions	Approx. W 212 × D 367 × H 345 mm					
Weight	Approx. 7.0 kg			Approx. 6.5 kg		
Display	OEL display (dot matrix)					
Input/Output Terminal	RS-232C (D-sub9P plug)	USB device (Type B)	Ionizer	RS-232C (D-sub9P plug)	USB device (Type B)	

*1 According to USP Chapter 41. This is the tested value by the weight of the balance's capacity of 5%.

*2 The response time value is typical.

*3 Non-condensing.

AP Series

AP124W AP124X AP124Y
 AP224W AP224X AP224Y
 AP324W AP324X AP324Y



EP-100 Electronic Printer



EP-110 Electronic Printer



STABLO-AP Ionizer



SMK-601 Specific Gravity Measurement Kit

Options

Description
EP-100 Electronic Printer
EP-110 Electronic Printer
LABEL ROLL PAPER, CEF45-S (10 sets)
Display protective cover (set of 5)
RS-232C Cable (1.5 m)
AC adapter (standard accessory)
Internal windbreak plate

External Dimensions of AP Series

(AP124W, AP224W, AP324W, AP124X, AP224X, AP324X) Weight: Approx. 7.0 kg

(AP124Y, AP224Y, AP324Y) Weight: Approx. 6.5 kg

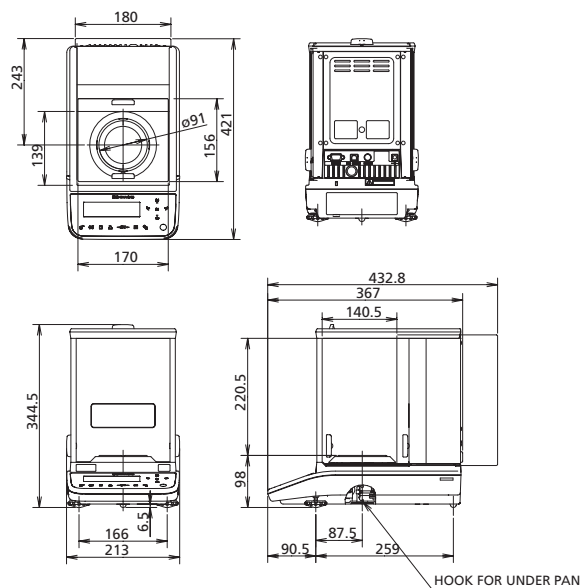

External Dimensions of STABLO-AP

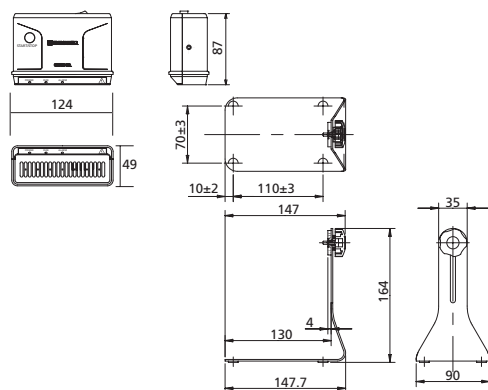

Static Electricity Remover 2-Way Ionizer Designed Specifically for Electronic Balances

Ion Generation Method	AC corona discharge method
Ion Balance	±10 V
Effective Static Removal Range	Approx. 50 mm to 400 mm from the outlet
Static Elimination Time (approx.)	1 second (Typical value) (from ±1000 V to ±100 V)
Ozone Concentration	0.06 ppm
Electrode Probes	Tungsten (durability: 30,000 hours)
Weight	Approx. 710 g (Main unit: 395 g, Stand: 315 g)
Operating Temperature and Humidity	0 °C to +40 °C, 25 % RH to 85 % RH (non-condensing)
Rated Electric Power Supply	DC 24 V, 1.0 A



For Research Use Only. Not for use in diagnostic procedures.

This publication may contain references to products that are not available in your country. Please contact us to check the availability of these products in your country.

Company names, products/service names and logos used in this publication are trademarks and trade names of Shimadzu Corporation, its subsidiaries or its affiliates, whether or not they are used with trademark symbol "TM" or "®".

Third-party trademarks and trade names may be used in this publication to refer to either the entities or their products/services, whether or not they are used with trademark symbol "TM" or "®".

Shimadzu disclaims any proprietary interest in trademarks and trade names other than its own.

The contents of this publication are provided to you "as is" without warranty of any kind, and are subject to change without notice. Shimadzu does not assume any responsibility or liability for any damage, whether direct or indirect, relating to the use of this publication.

Shimadzu Corporation

www.shimadzu.com/an/